

TABLE OF CONTENTS

GENERAL INFORMATION..... 4

PRODUCT DESCRIPTION FOR EQUIPMENT UNDER TEST (EUT)..... 4

OBJECTIVE 4

EQUIPMENT MODIFICATIONS..... 4

1 - EN61000-3-2..... 5

1.1 TEST EQUIPMENT LIST AND DETAILS 5

1.2 LIMITS 5

1.3 TEST PROCEDURE AND THE TEST SET-UP..... 5

1.4 TEST DATA AND RECORDS 6

1.5 VERDICT 6

2 - EN61000-3-3..... 7

2.1 TEST EQUIPMENT LIST AND DETAILS 7

2.2 LIMITS 7

2.3 TEST PROCEDURE AND THE TEST SET-UP..... 7

2.4 TEST DATA AND RECORDS 8

2.5 VERDICT 8

3 –EN55014-1 9

3.1 CONTINUOUS DISTURBANCE VOLTAGE AT MAINS TERMINAL..... 9

3.1.1 TEST EQUIPMENT LIST AND DETAILS..... 9

3.1.2 DESCRIPTION OF MEASUREMENT CONDITIONS..... 9

3.1.3 LIMITS OF CONTINUOUS DISTURBANCE VOLTAGE AT MAINS TERMINAL. 9

3.1.4 TEST PROCEDURE AND THE TEST SET-UP..... 10

SET-UP 10

3.1.5 TEST DATA AND RECORDS 10

3.1.6 VERDICT 10

3.2 RADIATED DISTURBANCES 11

3.2.1 TEST EQUIPMENT LIST AND DETAILS..... 11

3.2.2 DESCRIPTION OF MEASUREMENT CONDITIONS..... 11

3.2.3 LIMITS OF RADIATED DISTURBANCES OF CLASS B ITE AT A MEASURING DISTANCE OF 3M. 11

3.2.4 TEST PROCEDURE AND THE TEST SET-UP..... 11

3.2.5 TEST DATA AND RECORDS 12

3.2.6 VERDICT 13

3.3 DISTURBANCE POWER..... 14

3.3.1 TEST EQUIPMENT LIST AND DETAILS..... 14

3.3.2 DESCRIPTION OF MEASUREMENT CONDITIONS..... 14

3.3.3 LIMITS OF DISTURBANCE POWER 14

3.3.4 CONFIGURATION..... 14

3.3.5 TEST DATA AND RECORDS 15

3.3.6 VERDICT 15

3.4 DISCONTINUOUS DISTURBANCE VOLTAGE AT MAINS TERMINAL (CLICK) 16

3.4.1 TEST EQUIPMENT LIST AND DETAILS..... 16

3.4.2 DESCRIPTION OF MEASUREMENT CONDITIONS..... 16

3.4.3 LIMITS OF CLICK..... 16

3.4.4 CONFIGURATION..... 16

3.4.5 TEST DATA AND RECORDS 16

3.4.6 VERDICT..... 16

4 –EN55014-2 17

DESCRIPTION OF PERFORMANCE CRITERION (ACCORDING WITH EN55014-2 SECTION 6) 17

PERFORMANCE CRITERION A 17

PERFORMANCE CRITERION B 17

PERFORMANCE CRITERION C 17

4.1 SURGES..... 18

Test model: C0-F1

4.1.1 TEST EQUIPMENT LIST AND DETAILS..... 18
4.1.2 DESCRIPTION OF MEASUREMENT CONDITIONS..... 18
4.1.3 TEST PROCEDURE AND THE TEST SET-UP..... 18
4.1.4 TEST DATA AND RECORDS..... 19
4.1.5 VERDICT..... 19
4.2 ESD..... 20
4.2.1 TEST EQUIPMENT LIST AND DETAILS..... 20
4.2.2 DESCRIPTION OF MEASUREMENT CONDITIONS..... 20
4.2.3 TEST PROCEDURE AND THE TEST SET-UP..... 20
4.2.4 TEST DATA AND RECORDS..... 21
4.2.5 VERDICT..... 21
4.3 EFT/B..... 22
4.3.1 TEST EQUIPMENT LIST AND DETAILS..... 22
4.3.2 DESCRIPTION OF MEASUREMENT CONDITIONS..... 22
4.3.3 TEST PROCEDURE AND THE TEST SET-UP..... 22
4.3.4 TEST DATA AND RECORDS..... 23
4.3.5 VERDICT..... 23
4.4 INJECTED CURRENTS..... 24
4.4.1 TEST EQUIPMENT LIST AND DETAILS..... 24
4.4.2 DESCRIPTION OF MEASUREMENT CONDITIONS..... 24
4.4.3 TEST PROCEDURE AND THE TEST SET-UP..... 24
4.4.4 TEST DATA AND RECORDS..... 25
4.4.5 VERDICT..... 25
4.5 VOLTAGE DIPS AND INTERRUPTIONS..... 26
4.5.1 TEST EQUIPMENT LIST AND DETAILS..... 26
4.5.2 DESCRIPTION OF MEASUREMENT CONDITIONS..... 26
4.5.3 TEST PROCEDURE AND THE TEST SET-UP..... 26
4.5.4 TEST DATA AND RECORDS..... 27
4.5.5 VERDICT..... 27
4.6 RADIO-FREQUENCY ELECTROMAGNETIC FIELD..... 28
4.6.1 TEST EQUIPMENT LIST AND DETAILS..... 28
4.6.2 DESCRIPTION OF MEASUREMENT CONDITIONS..... 28
4.6.3 TEST PROCEDURE AND THE TEST SET-UP..... 28
4.6.4 TEST DATA AND RECORDS..... 29
4.6.5 VERDICT..... 29
APPENDIX A— TEST PHOTOGRAPH..... 30

1.1 Test Equipment List and Details

Manufacturer	Description	Model	Serial Number	Last Cal. Date	Cal. Period
EMC-PARTNER	Harmonics and Flicker Analyzer	HARMONIC S-1000	HAR1000-40	2014.7	2 Year

***Statement of Traceability: China Ceprei (Sichuan) Laboratory** certifies that all calibrations have been performed using suitable standards traceable to the CHINA SCIENTIFIC MEASUREMENT INSTITUTE.

1.2 Limits

Limits for Class A equipment

Harmonic order n	Maximum permissible harmonic current A
Odd harmonics	
3	2.30
5	1.14
7	0.77
9	0.40
11	0.33
13	0.21
$15 \leq n \leq 39$	$0.15 \frac{15}{n}$
Even harmonics	
2	1.08
4	0.43
6	0.30
$8 \leq n \leq 40$	$0.23 \frac{8}{n}$

1.3 Test procedure and the test set-up

Procedure

- a. The EUT was placed on the top of a wooden table 0.8 meters above the ground and operated to produce the maximum harmonic components under normal operating conditions for each successive harmonic component in turn.
- b. The classification of EUT is according to section 5 of EN 61000-3-2. The EUT is classified as follows:
 - Class A: Balanced three-phase equipment, Household appliances excluding equipment as Class D, Tools excluding portable tools, Dimmers for incandescent lamps, audio equipment, equipment not specified in one of the three other classes.
 - Class B: Portable tools. Arc welding equipment which is not professional equipment
 - Class C: Lighting equipment, including dimming devices.
 - Class D: Equipment having a specified power less than or equal to 600 W of the following types: Personal computers and personal computer monitors.
- c. The correspondent test program of test instrument to measure the current harmonics emanated from EUT is chosen. The measure time shall be not less than the time necessary for the EUT to be exercised.

Set-up

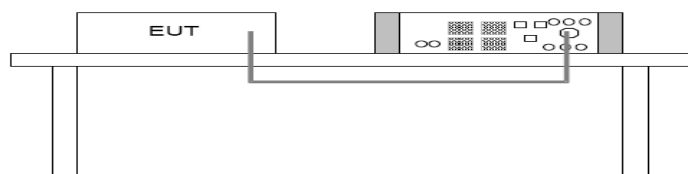

Test model: 0001

1.4 Test Data and Records

Order	Freq. [Hz]	Iavg [A]	Irms [A]	I _{max} [A]	Limit [A]	Status
1	50	1.2208	1.2164	1.2299		
2	100	0.0101	0.0098	0.0104	1.0800	
3	150	0.8020	0.7959	0.8115	2.3000	
4	200	0.0000	0.0043	0.0052	0.4300	
5	250	0.2725	0.2661	0.2802	1.1400	
6	300	0.0000	0.0027	0.0031	0.3000	
7	350	0.0547	0.0571	0.0571	0.7700	
8	400	0.0000	0.0012	0.0015	0.2300	
9	450	0.0909	0.0894	0.0928	0.4000	
10	500	0.0000	0.0003	0.0006	0.1840	
11	550	0.0000	0.0040	0.0061	0.3300	
12	600	0.0000	0.0006	0.0006	0.1533	
13	650	0.0410	0.0409	0.0412	0.2100	
14	700	0.0000	0.0003	0.0006	0.1314	
15	750	0.0115	0.0101	0.0131	0.1500	
16	800	0.0000	0.0003	0.0003	0.1150	
17	850	0.0196	0.0198	0.0201	0.1324	
18	900	0.0000	0.0003	0.0003	0.1022	
19	950	0.0118	0.0107	0.0128	0.1184	
20	1000	0.0000	0.0003	0.0003	0.0920	
21	1050	0.0074	0.0098	0.0098	0.1071	
22	1100	0.0000	0.0000	0.0003	0.0836	
23	1150	0.0100	0.0095	0.0107	0.0978	
24	1200	0.0000	0.0000	0.0000	0.0767	
25	1250	0.0000	0.0043	0.0043	0.0900	
26	1300	0.0000	0.0000	0.0003	0.0708	
27	1350	0.0000	0.0076	0.0082	0.0833	
28	1400	0.0000	0.0000	0.0000	0.0657	
29	1450	0.0000	0.0012	0.0012	0.0776	
30	1500	0.0000	0.0000	0.0003	0.0613	
31	1550	0.0000	0.0058	0.0061	0.0726	
32	1600	0.0000	0.0000	0.0000	0.0575	
33	1650	0.0000	0.0006	0.0015	0.0682	
34	1700	0.0000	0.0000	0.0000	0.0541	
35	1750	0.0000	0.0043	0.0043	0.0643	
36	1800	0.0000	0.0000	0.0000	0.0511	
37	1850	0.0000	0.0015	0.0024	0.0608	
38	1900	0.0000	0.0000	0.0000	0.0484	
39	1950	0.0000	0.0031	0.0031	0.0577	
40	2000	0.0000	0.0000	0.0000	0.0460	

1.5 Verdict

The EUT met the requirement.

Report # SCC (F1) 0001-0001-0001-0001

Test model: 0001

2 - EN61000-3-3

2.1 Test Equipment List and Details

Manufacturer	Description	Model	Serial Number	Last Cal. Date	Cal. Period
EMC-PARTNER	Harmonics and Flicker Analyzer	HARMONIC S-1000	HAR1000-40	2014.7	2 Year

***Statement of Traceability: China Ceprei (Sichuan) Laboratory** certifies that all calibrations have been performed using suitable standards traceable to the CHINA SCIENTIFIC MEASUREMENT INSTITUTE.

2.2 Limits

- The value of P_{st} shall not be greater than 1.0;
- The value of Plt shall not be greater than 0.65;
- The value of $d(t)$ during a voltage change shall not exceed 3.3% for more than 500ms;
- The relative steady-state voltage change, dc , shall not exceed 3.3%;
- The maximum relative voltage change, d_{max} , shall not exceed 4%.

Notes:

P_{st} : Short-term flicker indicator The flicker severity evaluated over a short period (in minutes); $P_{st}=1$ is the conventional threshold of irritability;

Plt : long-term flicker indicator; the flicker severity evaluated over a long period (a few hours) Using successive P_{st} values;

dc : the relative steady-state voltage change ;

d_{max} : maximum relative voltage change ;

$d(t)$: the value during a voltage change .

2.3 Test procedure and the test set-up

Procedure

- a. The EUT was placed on the top of a wooden table 0.8 meters above the ground and operated to produce the most unfavorable sequence of voltage changes under normal operating conditions.
- b. During the flick measurement, the measure time shall include that part of whole operation cycle in which the EUT produce the most unfavorable sequence of voltage changes. The observation period for short-term flicker indicator is 10 minutes and the observation period for long-term flicker indicator is 2 hours.

Set-up

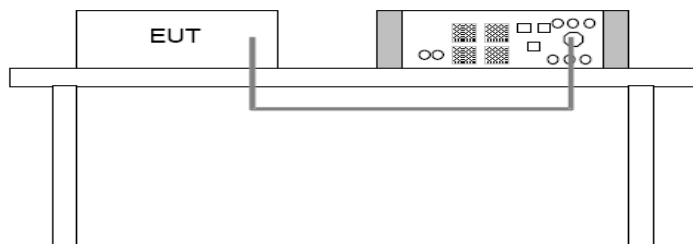

Test model: 001

2.4 Test Data and Records

Flicker and Voltage Fluctuation	Limit	Value
Short-term flicker Indicator Pst	1.0	0.167
Long -term flicker Indicator Plt	0.65	0.163
Relative Steady-state Voltage Change dc [%]	3.3	0.215
Maximum Relative Voltage Change dmax [%]	4.0	1.375
Relative Voltage Change Characteristic dt [s]	0.50	0.000

Result: PASSED

2.5 Verdict

The EUT met the requirement.

Test model: ÖÖËÍ
3 –EN55014-1

3.1 Continuous Disturbance Voltage at Mains Terminal.

3.1.1 Test Equipment List and Details

Manufacturer	Description	Model	Serial Number	Last Cal. Date	Cal. Period
Albatross Projects GmbH	Shield Room	Site 1	---	2014.10	2 Year
R&S	EMI Test Receiver	ESU40	1302	2015.8	1 Year
R&S	Artificial Mains	ENV216	1107	2014.2	2 Year
R&S	EMI Test System Cabinet	---	---	N/A	N/A
R&S	EMI Test Software	EMC32	---	N/A	N/A

*Statement of Traceability: China Ceprei (Sichuan) Laboratory certifies that all calibrations have been performed using suitable standards traceable to the CHINA SCIENTIFIC MEASUREMENT INSTITUTE.

3.1.2 Description of Measurement Conditions

Temperature: 21°C
 Humidity: 58%
 Pressure: 1033mbar
 Electromagnetic environment: normal

3.1.3 Limits of Continuous Disturbance Voltage at Mains Terminal.

Equipment type	Frequency range MHz	Limit values dB μ V	
		Quasi-peak	Average
Household appliance	0.15 to 0.5	66-56 ^a	56- 46 ^a
	0.5 to 5	56	46
	5 to 30	60	50

^a Decreasing linearly with logarithm of the frequency.

Note: If the limit for the measurement with the average detector is met when using a receiver with a quasi-peak detector, the equipment under test shall be deemed to meet both limits and the measurement using the receiver with an average detector need not be carried out.

Test model: ÔÓËÍ

3.1.4 Test procedure and the test set-up

Procedure

- a. The EUT was placed 0.4 meters from the conducting wall of the shielded room with EUT being connected to the power mains through a line impedance stabilization network (LISN). Other support units were connected to the power mains through another LISN. The two LISNs provide 50 Ohm/ 50uH of coupling impedance for the measuring instrument.
- b. Both lines of the power mains connected to the EUT were checked for maximum conducted interference.
- c. The frequency range from 150 kHz to 30 MHz was searched. Emission levels under limit -20dB of the prescribed limits could not be reported.

Set-up

The configuration is in accordance with the requirement in EN61000-6-3, the sketch map as follow:

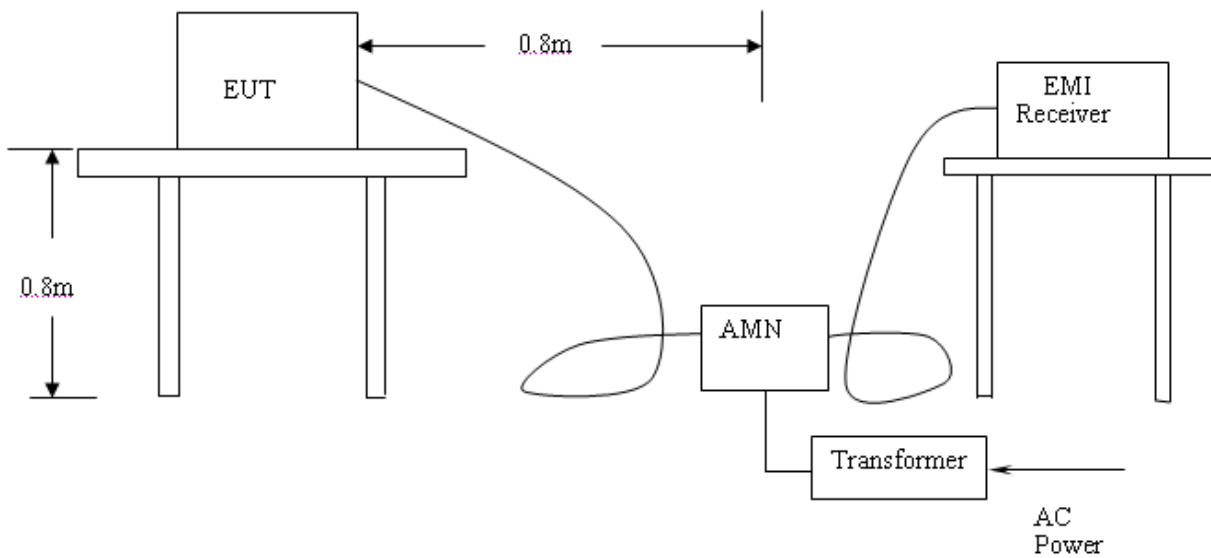

3.1.5 Test Data and Records

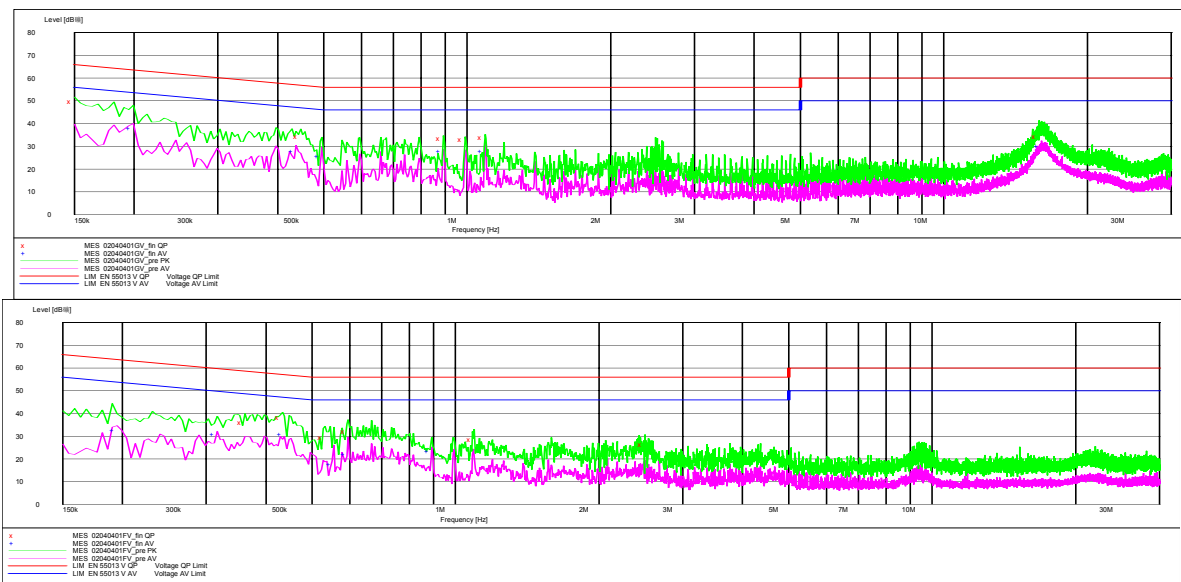

3.1.6 Verdict

The EUT met the requirement.

Report # SCC (FÍ DÍ FH-OËÛ-ÉÖT Ô

Test model: 0001

3.2 Radiated disturbances

3.2.1 Test Equipment List and Details

Manufacturer	Description	Model	Serial Number	Last Cal. Date	Cal. Period
Albatross Projects GmbH	Anechoic Chamber	---	9290832	2014.10	2 Year
R&S	Ultra-broadband Antennas	HL562	---	2017.1	2 Year
Inn-co GmbH	Antenna Towers	---	---	N/A	N/A
R&S	EMI Test Receiver	ESU40	1302	2015.8	1 Year
Inn-co GmbH	Turntable	DS2000S-1t		N/A	N/A
Inn-co GmbH	Controller	CO 2000	10806L	N/A	N/A
R&S	EMI Test Software	EMC32	---	N/A	N/A
R&S	EMI Test System Cabinet	---	---	N/A	N/A

***Statement of Traceability: China Ceprei (Sichuan) Laboratory** certifies that all calibrations have been performed using suitable standards traceable to the CHINA SCIENTIFIC MEASUREMENT INSTITUTE.

3.2.2 Description of Measurement Conditions

Temperature: 20°C
 Humidity: 60%
 Pressure: 1033mbar
 Electromagnetic environment: normal

3.2.3 Limits of radiated disturbances of class B ITE at a measuring distance of 3m.

Frequency range MHz	Quasi-peak limits(3m) dB(µV/m)
30 to 230	40
230 to 1000	47

NOTE: The lower limit shall apply at the transition frequency.
 NOTE: Additional provisions may be required for cases where interference occurs.

3.2.4 Test procedure and the test set-up

Procedure

- a. The EUT was placed on the top of a rotating table 0.8 meters above the ground at a 3m semi/full-anechoic chamber. The table was rotated 360 degrees to determine the position of the highest radiation.

Test model:

- b. The EUT was set 3 meters away from the interference-receiving antenna, which was mounted on the top of a variable-height antenna tower.
- c. The antenna is a broadband antenna, and its height is varied from one meter to four meters above the ground to determine the maximum value of the field strength. Both horizontal and vertical polarization of the antenna are set to make the measurement.
- d. For each suspected emission, the EUT was arranged to its worst case and then the antenna was tuned to heights from 1 meter to 4 meters and the turn table was turned from 0 degrees to 360 degrees to find the maximum reading.
- e. The test-receiver system was set to Peak Detect Function and Specified Bandwidth with Maximum Hold Mode.
- f. If the emission level of the EUT in peak mode was 10 dB lower than the limit specified, then testing could be stopped and the peak values of the EUT would be reported. Otherwise the emissions that did not have 10 dB margin would be retested one by one using the quasi- peak method or average method as specified and then reported In Data sheet peak mode and QP mode.

Set-up

The configuration is in accordance with the requirement in EN 55022, the sketch map as follow:

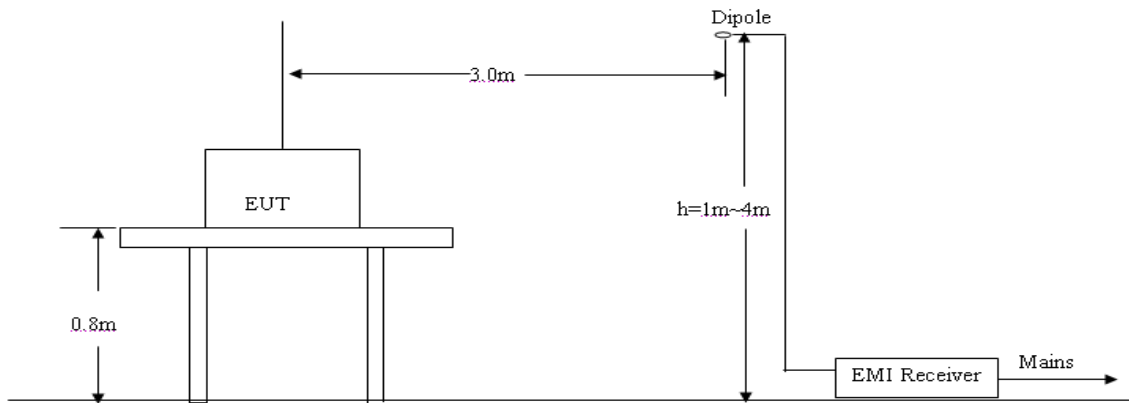

3.2.5 Test Data and Records

Test model: ÔÖËÍ

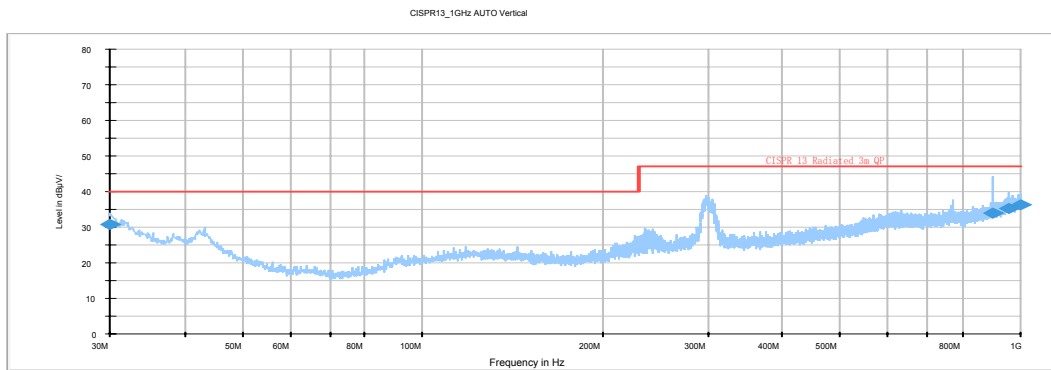
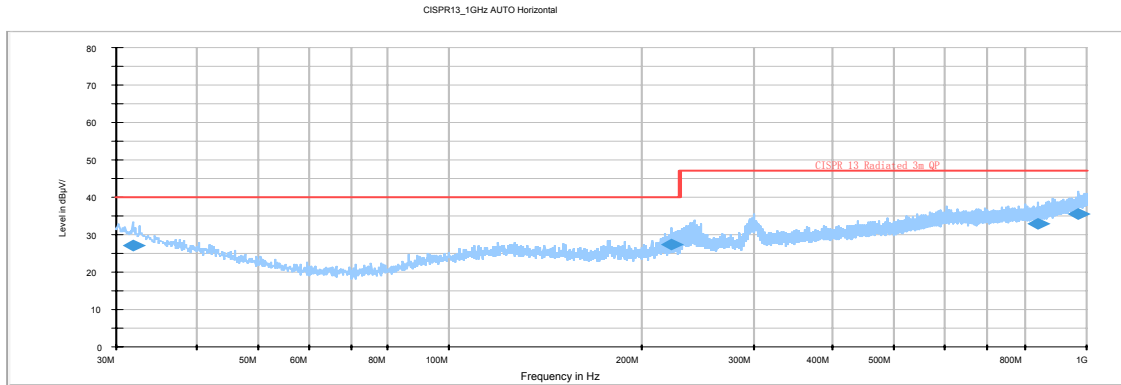

3.2.6 Verdict

The EUT met the requirement.

Test model: 0001

3.3 Disturbance Power

3.3.1 Test Equipment List and Details

Manufacturer	Description	Model	Serial Number	Last Cal. Date	Cal. Period
R&S	Absorbing Clamp	MDS-21	0194	2017.1	2 Year
R&S	EMI Test Receiver	ESU40	1302	2015.8	1 Year
R&S	EMI Test System Cabinet	---	---	N/A	N/A
Albatross Projects GmbH	Shield Room	Site 1	---	2014.10	2 Year
R&S	EMI Test Software	EMC32	---	N/A	N/A

*Statement of Traceability: China Ceprei (Sichuan) Laboratory certifies that all calibrations have been performed using suitable standards traceable to the CHINA SCIENTIFIC MEASUREMENT INSTITUTE.

3.3.2 Description of Measurement Conditions

Temperature: 21°C
 Humidity: 56%
 Pressure: 1033mbar
 Electromagnetic environment: normal

3.3.3 Limits of Disturbance Power

Equipment type	Frequency range MHz	Limit values (dBpW)	
		Quasi-peak	Average
Tools	30 to 300	55 to 65 ^a	45 to 55 ^a

^a Increasing linearly with frequency.

3.3.4 Configuration

The configuration in accordance with the requirement in EN55014-1, the sketch map as follow:

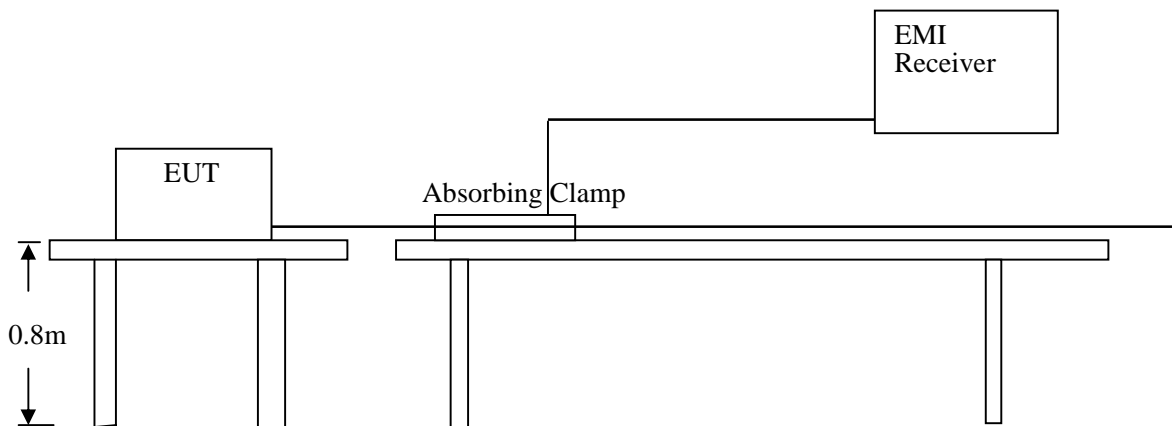

Test model: 0001

3.3.5 Test Data and Records

DATA CABLE DISTURBANCE POWER			
Frequency	Amplitude	Detector	Limit
MHz	dBpW	Qp/Ave/Peak	dBpW
30 to 300	*	Qp	55 to 65 ^a

^a Increasing linearly with frequency.
** Means the continuous disturbance voltage level 6dB lower than limits.

3.3.6 Verdict

The EUT met the requirement.

Test model: 0001

3.4 Discontinuous Disturbance Voltage at Mains Terminal (Click)

3.4.1 Test Equipment List and Details

Manufacturer	Description	Model	Serial Number	Last Cal. Date	Cal. Period
Albatross Projects GmbH	Shield Room	Site 1	---	2014.10	2 Year
AFJ	Click Meter	CL55C	5040019044	2015.8	1 Year
AFJ	Artificial Mains (Two Line)	LS16C	16010020077	2017.2	2 Year

*Statement of Traceability: China Ceprei (Sichuan) Laboratory certifies that all calibrations have been performed using suitable standards traceable to the CHINA SCIENTIFIC MEASUREMENT INSTITUTE.

3.4.2 Description of Measurement Conditions

Temperature: 22°C
 Humidity: 56%
 Pressure: 1033mbar
 Electromagnetic environment: normal

3.4.3 Limits of Click

For discontinuous disturbance, the click limit is attained by increasing the relevant limit of Continuous Disturbance Voltage with:

$$44\text{dB} \quad \text{for} \quad N < 0.2 \quad \text{or} \\ 20\lg(30/N) \text{ dB} \quad \text{for} \quad 0.2 \leq N < 30$$

3.4.4 Configuration

The configuration in accordance with the requirement in EN55014-1, the sketch map as follow:

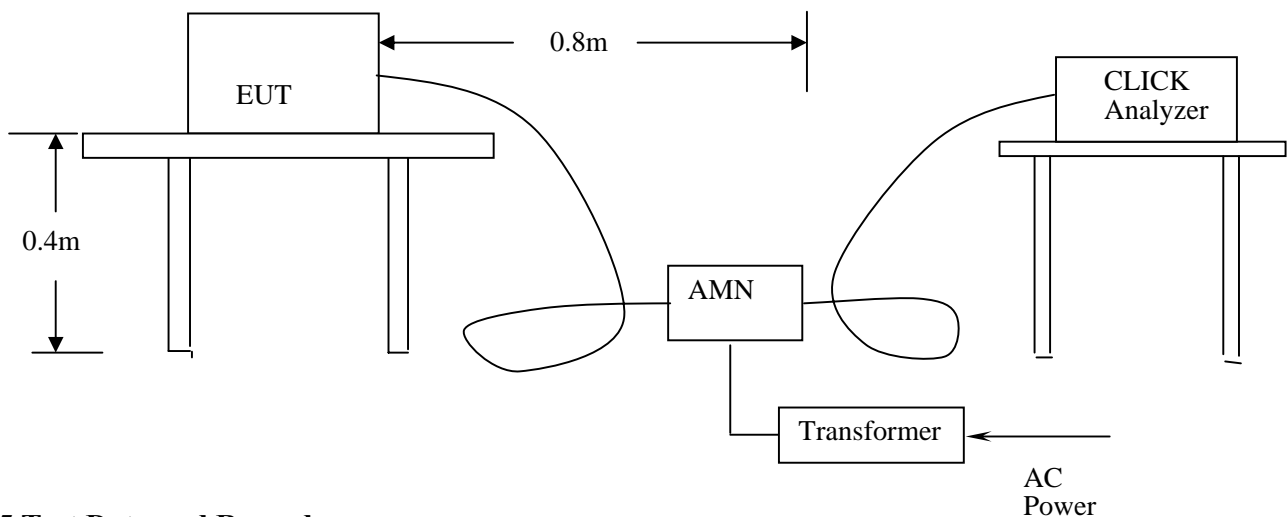

3.4.5 Test Data and Records

test case does not apply to the test object

3.4.6 Verdict

The EUT met the requirement.

Report # SCC (F1) 011-011-011-011-011-011

Description of Performance Criterion (According with EN55014-2 Section 6)

Performance Criterion A

The apparatus shall continue to operate as intended during the test. No degradation of performance or loss of function is allowed below a performance level (or permissible loss of performance) specified by the manufacturer, when the apparatus is used as intended. If the minimum performance level or the permissible performance loss is not specified by the manufacture, then either of these may be derived from the product description and documentation, and from what the user may reasonably expect from the apparatus if used as intended.

Performance Criterion B

The apparatus shall continue to operate as intended after the test. No degradation of performance or loss of function is allowed below a performance level (or permissible loss of performance) specified by the manufacturer, when the apparatus is used as intended. During the test, degradation of performance is allowed, however, no change of actual operating state or stored data is allowed. If the minimum performance level or the permissible performance loss is not specified by the manufacture, then either of these may be derived from the product description and documentation, and from what the user may reasonably expect from the apparatus if used as intended.

Performance Criterion C

Temporary loss of function is allowed, provided the function is self-recoverable or can be restored by the operation of the controls, or by any operation specified in the instructions for use.

Test model: 0001
 4.1 SURGES

4.1.1 Test Equipment List and Details

Manufacturer	Description	Model	Serial Number	Last Cal. Date	Cal. Period
Noise Laboratory CO., LTD	Surge Lite	LSS-6030	9099E00350	2014.11	2 Year

*Statement of Traceability: China Ceprei (Sichuan) Laboratory certifies that all calibrations have been performed using suitable standards traceable to the CHINA SCIENTIFIC MEASUREMENT INSTITUTE.

4.1.2 Description of Measurement Conditions

Temperature: 21°C
 Humidity: 58%
 Pressure: 1033mbar
 Electromagnetic environment: normal

4.1.3 test procedure and the test set-up

Procedure

- a. For EUT power supply:
 The surge is to be applied to the EUT power supply terminals via the capacitive coupling network. Decoupling networks are required in order to avoid possible adverse effects on equipment not under test that may be powered by the same lines, and to provide sufficient decoupling impedance to the surge wave. The power cord between the EUT and the coupling/decoupling networks shall be 2 meters in length (or shorter).
- b. For test applied to unshielded unsymmetrically operated interconnection lines of EUT:
 The surge is applied to the lines via the capacitive coupling. The coupling / decoupling networks shall not influence the specified functional conditions of the EUT. The interconnection line between the EUT and the coupling/decoupling networks shall be 2 meters in length (or shorter).
- c. For test applied to unshielded symmetrically operated interconnection / telecommunication lines of EUT:
 The surge is applied to the lines via gas arrestors coupling. Test levels below the ignition point of the coupling arrestor cannot be specified. The interconnection line between the EUT and the coupling/decoupling networks shall be 2 meters in length (or shorter).
- a. Both positive and negative polarity discharges were applied.

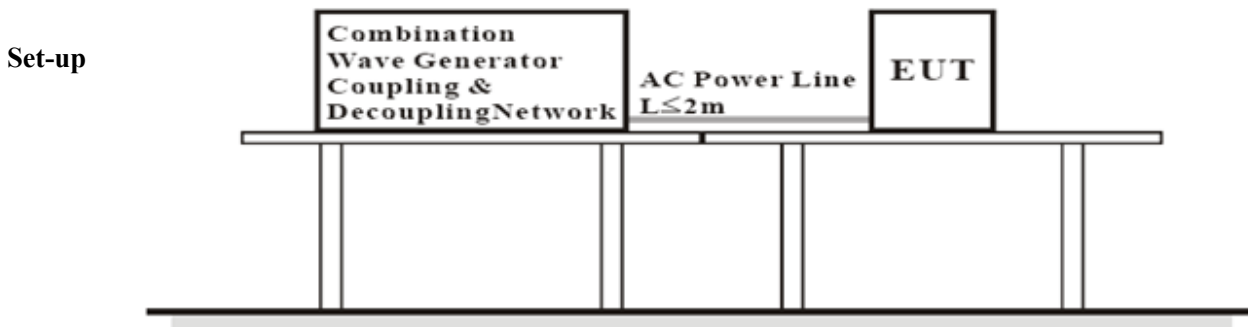

Test model: 0001

4.1.4 Test Data and Records

Terminal	Voltage	Path	Phase	Number Of Impulses	Pass	Fail
	KV					
MAINS	±1	L-N	0°	5	B	
MAINS	±1	L-N	90°	5	B	
MAINS	±1	L-N	180°	5	B	
MAINS	±1	L-N	270°	5	B	
MAINS	±2	L-PE N-PE	0°	5	B	
MAINS	±2	L-PE N-PE	90°	5	B	
MAINS	±2	L-PE N-PE	180°	5	B	
MAINS	±2	L-PE N-PE	270°	5	B	

4.1.5 Verdict

The EUT was working as normal, so they met the requirement of performance criteria B.

Test model: 0001

4.2 ESD

4.2.1 Test Equipment List and Details

Manufacturer	Description	Model	Serial Number	Last Cal. Date	Cal. Period
Shanghai Sanki	Electrostatic Discharge tester	ESD-320	0329501C	2014.6	2 Year

***Statement of Traceability: China Ceprei (Sichuan) Laboratory** certifies that all calibrations have been performed using suitable standards traceable to the CHINA SCIENTIFIC MEASUREMENT INSTITUTE.

4.2.2 Description of Measurement Conditions

Temperature: 21 °C

Humidity: 58%

Pressure: 1033mbar

Electromagnetic environment: normal

4.2.3 Test procedure and the test set-up

Procedure

- Electrostatic discharges were applied only to those points and surfaces of the EUT that are accessible to users during normal operation.
- The test was performed with at least ten single discharges on the pre-selected points in the most sensitive polarity.
- The time interval between two successive single discharges was at least 1 second.
- The ESD generator was held perpendicularly to the surface to which the discharge was applied and the return cable was at least 0.2 meters from the EUT.
- Contact discharges were applied to the non-insulating coating, with the pointed tip of the generator penetrating the coating and contacting the conducting substrate.
- Air discharges were applied with the round discharge tip of the discharge electrode approaching the EUT as fast as possible (without causing mechanical damage) to touch the EUT. After each discharge, the ESD generator was removed from the EUT and re-triggered for a new single discharge. The test was repeated until all discharges were complete.
- At least ten single discharges (in the most sensitive polarity) were applied at the front edge of each Horizontal Coupling Plane opposite the center point of each unit of the EUT and 0.1 meters from the front of the EUT. The long axis of the discharge electrode was in the plane of the HCP and perpendicular to its front edge during the discharge.
- At least ten single discharges (in the most sensitive polarity) were applied to the center of one vertical edge of the Vertical Coupling Plane in sufficiently different positions that the four faces of the EUT were completely illuminated. The VCP (dimensions 0.5m x 0.5m) was placed vertically to and 0.1 meters from the EUT.

Test model: 0001

Set-up

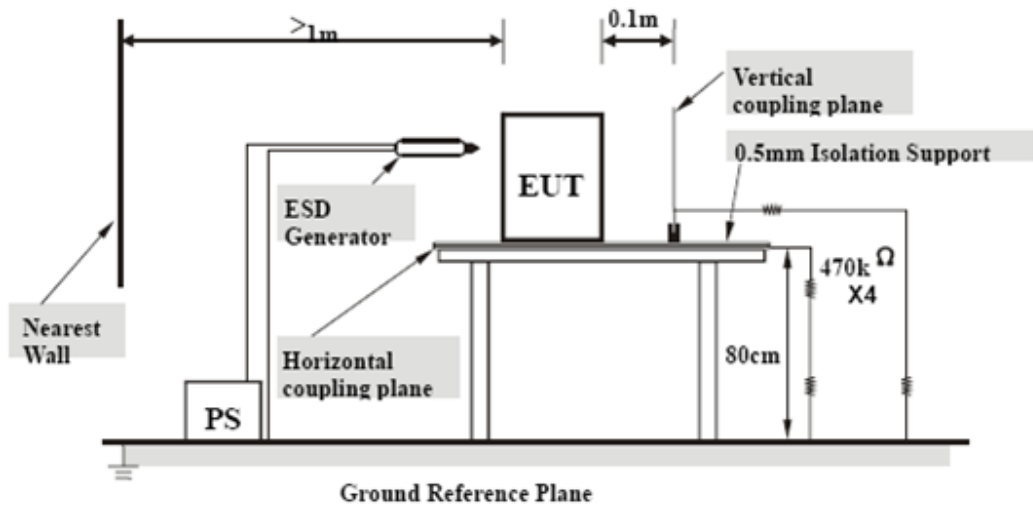

4.2.4 Test Data and Records

Air Discharge

Test Levels																
EN61000-4-2 Test Points	-2 kV	+2 kV	-4 kV	+4 kV	-6 kV	+6 kV	-8 kV	+8 kV	-10 kV	+10 kV	-12.5 kV	+12.5 kV	-15 kV	+15 kV	-20 kV	+20 kV
EUT Front Side	B	B	B	B	B	B	B	B								
EUT Top Side	B	B	B	B	B	B	B	B								
EUT Back Side	B	B	B	B	B	B	B	B								
EUT Left Side	B	B	B	B	B	B	B	B								
EUT Right Side	B	B	B	B	B	B	B	B								

Direct Contact

Test Levels																
EN61000-4-2 Test Points	-2 kV	+2 kV	-4 kV	+4 kV	-6 kV	+6 kV	-8 kV	+8 kV	-10 kV	+10 kV	-12.5 kV	+12.5 kV	-15 kV	+15 kV	-20 kV	+20 kV
EUT Front Side	B	B	B	B												
EUT Top Side	B	B	B	B												
EUT Back Side	B	B	B	B												
EUT Left Side	B	B	B	B												
EUT Right Side	B	B	B	B												

4.2.5 Verdict

The EUT was working as normal, so they met the requirement of performance criteria B.

Test model: 069504E
 4.3 EFT/B

4.3.1 Test Equipment List and Details

Manufacturer	Description	Model	Serial Number	Last Cal. Date	Cal. Period
Shanghai Sanki	E.F.TB Generator	8014	069504E	2015.3	2 Year

*Statement of Traceability: China Ceprei (Sichuan) Laboratory certifies that all calibrations have been performed using suitable standards traceable to the CHINA SCIENTIFIC MEASUREMENT INSTITUTE.

4.3.2 Description of Measurement Conditions

Temperature: 21°C
 Humidity: 58%
 Pressure: 1033mbar
 Electromagnetic environment: normal

4.3.3 Test procedure and the test set-up

Procedure

- a. Both positive and negative polarity discharges were applied.
- b. The length of the “hot wire” from the coaxial output of the EFT generator to the terminals on the EUT should not exceed 1 meter.
- c. The duration time of each test sequential was 1 minute.
- d. The transient/burst waveform was in accordance with IEC 61000-4-4, 5/50ns.

Set-up

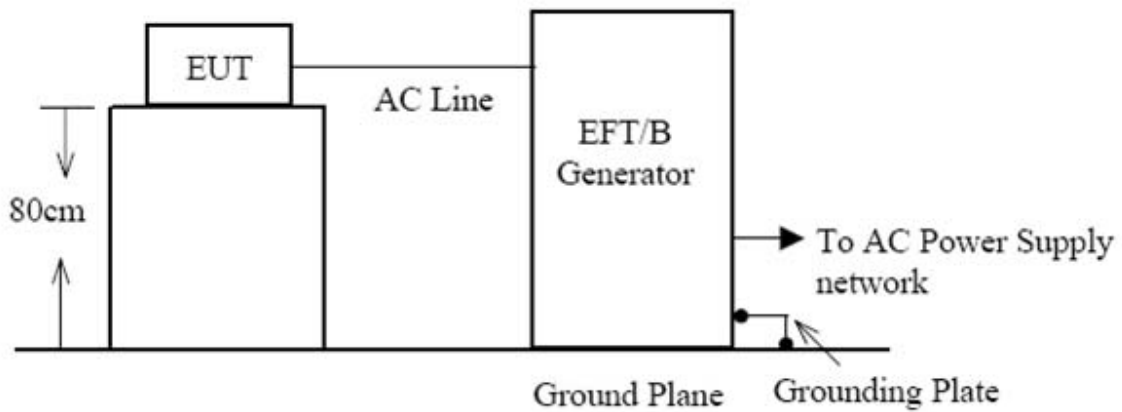

Test model: 0001

4.3.4 Test Data and Records

Test Levels (kV)									
EN61000-4-4 Test Points		+0.25	-0.25	+0.5	-0.5	+1.0	-1.0	+2.0	-2.0
Power Port of EUT	L 1	A	A	A	A	A	A		
	N	A	A	A	A	A	A		
	L1+ N+PE	A	A	A	A	A	A		

4.3.5 Verdict

The EUT was working as normal, so they met the requirement of performance criteria A.

Test model: 0001

4.4 INJECTED CURRENTS

4.4.1 Test Equipment List and Details

Manufacturer	Description	Model	Serial Number	Last Cal. Date	Cal. Period
Giga-tronics	Synthesized RF Signal Generator	6061A	5130304	2017.2	2 Year
QF	Broadband Power Amplifier	QF3860	---	2017.2	2 Year
QF	Millivoltmeter	QF2281	92028	2017.2	2 Year

***Statement of Traceability: China Ceprei (Sichuan) Laboratory** certifies that all calibrations have been performed using suitable standards traceable to the CHINA SCIENTIFIC MEASUREMENT INSTITUTE.

4.4.2 Description of Measurement Conditions

Temperature: 21°C
 Humidity: 58%
 Pressure: 1033mbar
 Electromagnetic environment: normal

4.4.3 Test procedure and the test set-up

Procedure

- a. The EUT shall be tested within its intended operating and climatic conditions.
- b. The test shall be performed with the test generator connected to each of the coupling and decoupling devices in turn, while the other non-excited RF input ports of the coupling devices are terminated by a 50-ohm load resistor.
- c. The frequency range is swept from 150 kHz to 230 MHz, using the signal level established during the setting process and with a disturbance signal of 80 % amplitude. The signal is modulated with a 1 kHz sine wave, pausing to adjust the RF signal level or the switch coupling devices as necessary. The sweep rate shall not exceed 1.5×10^{-3} decades/s. The step size shall not exceed 1 % of the start and thereafter 1 % of the preceding frequency value where the frequency is swept incrementally.
- d. The dwell time at each frequency shall not be less than the time necessary for the EUT to be exercised, and able to respond. Sensitive frequencies such as clock frequency(ies) and harmonics or frequencies of dominant interest, shall be analyzed separately.
- e. Attempts should be made to fully exercise the EUT during testing, and to fully interrogate all exercise modes selected for susceptibility.

Set-up

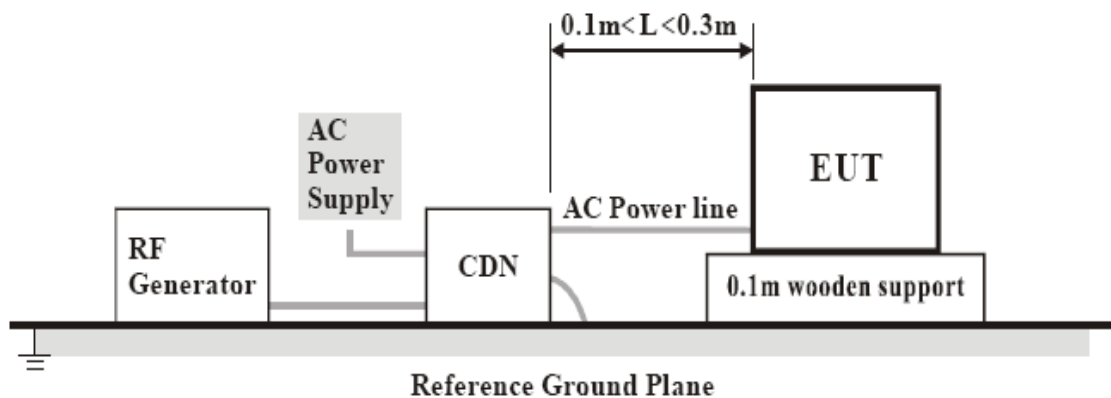

Test model: 0001

4.4.4 Test Data and Records

EN61000-4-6 Test Points	Frequency range MHz	Levels	Voltage Level (e.m.f.)V	Pass	Fail
Power Line	0.15-230MHz	1	1		
		2	3	A	
		3	10		
		X	Special		

4.4.5 Verdict

The EUT was working as normal, so they met the requirement of performance criteria A.

Test model: 0001

4.5 VOLTAGE DIPS AND INTERRUPTIONS

4.5.1 Test Equipment List and Details

Manufacturer	Description	Model	Serial Number	Last Cal. Date	Cal. Period
Noise Laboratory CO., LTD	Voltage Dip Simulator	VDS-220B	2199D00098	2014.10	2 Year

***Statement of Traceability: China Ceprei (Sichuan) Laboratory** certifies that all calibrations have been performed using suitable standards traceable to the CHINA SCIENTIFIC MEASUREMENT INSTITUTE.

4.5.2 Description of Measurement Conditions

Temperature: 21°C
Humidity: 58%
Pressure: 1033mbar
Electromagnetic environment: normal

4.5.3 Test procedure and the test set-up

Procedure

The EUT shall be tested for each selected combination of test levels and duration with a sequence of three dips/interruptions with intervals of 10 s minimum (between each test event). Each representative mode of operation shall be tested. Abrupt changes in supply voltage shall occur at zero crossings of the voltage waveform.

Set-up

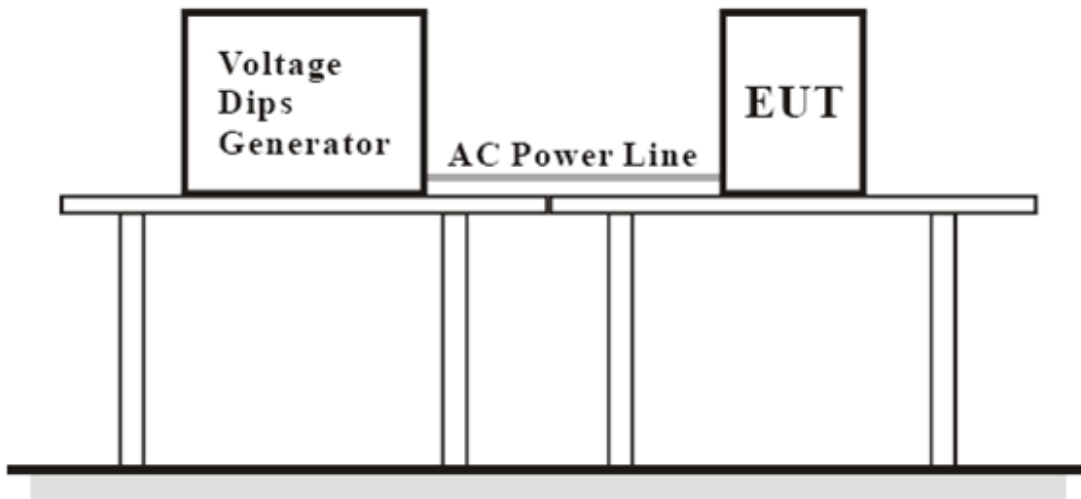

Test model: ÖNIEI

4.5.4 Test Data and Records

Environmental phenomena		Test level in % U_T	Duration (in periods of the rated frequency)	Phase Angle	Pass	Fail
Interruptions		0	0.5T	0/180	C	
Voltage dips in % U_T	60	40	10T	0/180	C	
	30	70	50T	0/180	C	

4.5.5 Verdict

The EUT was working as normal, so they met the requirement of performance criteria C.

Test model: 0001

4.6 Radio-frequency electromagnetic field

4.6.1 Test Equipment List and Details

Manufacturer	Description	Model	Serial Number	Last Cal. Date	Cal. Period
R&S	Signal Generator	SMR-40	1104	2015.8	1 Year
QF	Broadband Power Amplifier	QF3860	---	2017.2	2 Year
QF	Millivoltmeter	QF2281	92028	2017.2	2 Year
Albatross Projects GmbH	Anechoic Chamber	---	9290832	2014.10	2 Year
R&S	Ultra-broadband Antennas	HL562	---	2017.1	2 Year
Inn-co GmbH	Antenna Towers	---	---	N/A	N/A
Inn-co GmbH	Turntable	DS2000S-1t	---	N/A	N/A
Inn-co GmbH	Controller	CO 2000	10806L	N/A	N/A

***Statement of Traceability: China Ceprei (Sichuan) Laboratory** certifies that all calibrations have been performed using suitable standards traceable to the CHINA SCIENTIFIC MEASUREMENT INSTITUTE.

4.6.2 Description of Measurement Conditions

Temperature: 20°C
Humidity: 60%
Pressure: 1033mbar
Electromagnetic environment: normal

4.6.3 Test procedure and the test set-up

Procedure

The test procedure was in accordance with EN 61000-4-3

- The testing was performed in a fully-anechoic chamber. The transmit antenna was located at a distance of 3 meters from the EUT.
- The frequency range is swept from 80 MHz to 1000 MHz with the signal 80% amplitude modulated with a 1kHz sinewave. The rate of sweep did not exceed 1.5×10^{-3} decade/s. Where the frequency range is swept incrementally, the step size was 1 % of preceding frequency value.
- The dwell time at each frequency shall be not less than the time necessary for the EUT to be able to respond.
- The field strength level was 3V/m.
- The test was performed with the EUT exposed to both vertically and horizontally polarized fields on each of the four sides.

Test model: 0001

Set-up

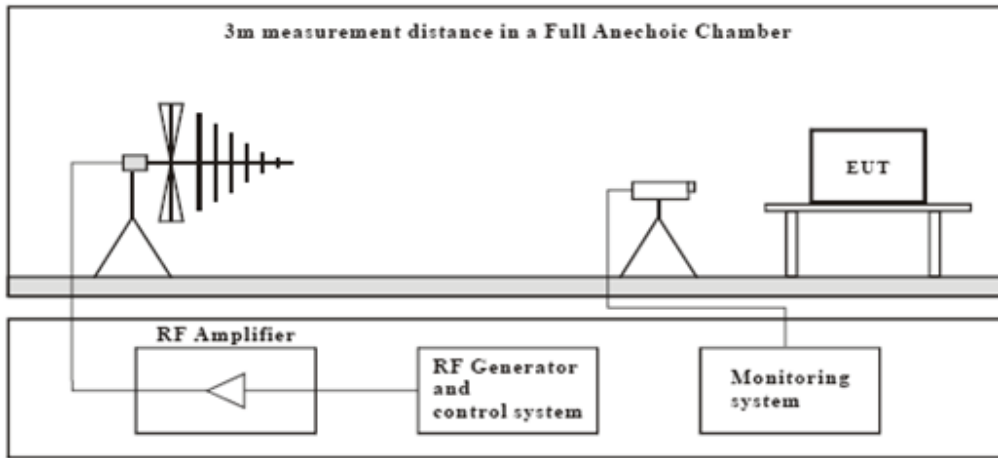

4.6.4 Test Data and Records

The EUT was tested that it worked at the normal state.

Frequency Range (MHz)	Front Side (3 V/m)		Rear Side (3 V/m)		Left Side (3 V/m)		Right Side (3 V/m)	
	VERT	HORI	VERT	HORI	VERT	HORI	VERT	HORI
80-1000	A	A	A	A	A	A	A	A

4.6.5 Verdict

The EUT was working as normal, so it met the requirement of performance criteria A.

Test model: ÔÓËÍ

APPENDIX A— TEST PHOTOGRAPH



Test model: ÔÓËÍ



Test model: ÔÓËÍ



Notice

1. This test report shall be invalid without the cachet of the testing laboratory.
2. This copied report shall be invalid without the sealed cachet of the testing laboratory.
3. This report shall be invalid without tester signature, reviewer signature and approver signature.
4. This report is invalid if altered.
5. Client shall put forward demurrer within 15days after receipt of report. The testing laboratory shall refuse disposal if exceeded the time limit.
6. The test results presented in this report relate only to the object tested.

Tel: 028-84847518

Post code: 610100

Add: No.45 Wenming Dong Road Longquangyi District, Chengdu, Sichuan.

Note: This report may not be duplicated without prior written consent of China CEPREI (Sichuan) Laboratory.